

ELEKTROSCHEMA

Projektbeschreibung: INNOXEL System AG
INNOXEL-NOXnet-v3

Objekt: INNOXEL System AG

Mattenstrasse 18
3661 Uetendorf

Kunde: INNOXEL System AG

Auftrags-Nummer: 01-12-2017

Schema-Nummer:

TinLine GmbH

CAD/CAE für die Elektrotechnik
Schürmattstrasse 4
CH-5643 Sins www.tinline.ch
Tel: 041/787 35 35 Fax: 041/787 35 32

Index	Datum	Name	Erstellt	TinLine
			Datum	01.12.2017
			Geprüft	
			Blatt	1
			Druck	30.11.2017
Anzahl Seiten	22		17.3	16:19

1

2

3

4

5

6

7

8

A

A

B

B

C

C

D

D

E

E

F

F

10A2

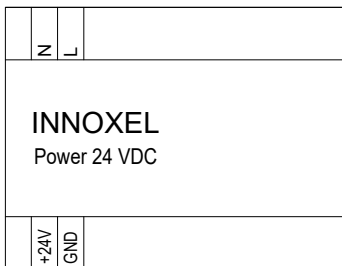

TinLine GmbH

Index	Datum	Name	Gezeichnet TinLine	INNOXEL System AG	<u>TinLine GmbH</u>	INNOXEL	Auftrag:	01-12-2017	Blatt	10
			Erstelldatum 01.12.2017	INNOXEL-NOXnet-v3		Power 24 VDC	Schema:		< 2	11 >

1

2

3

4

5

6

7

8

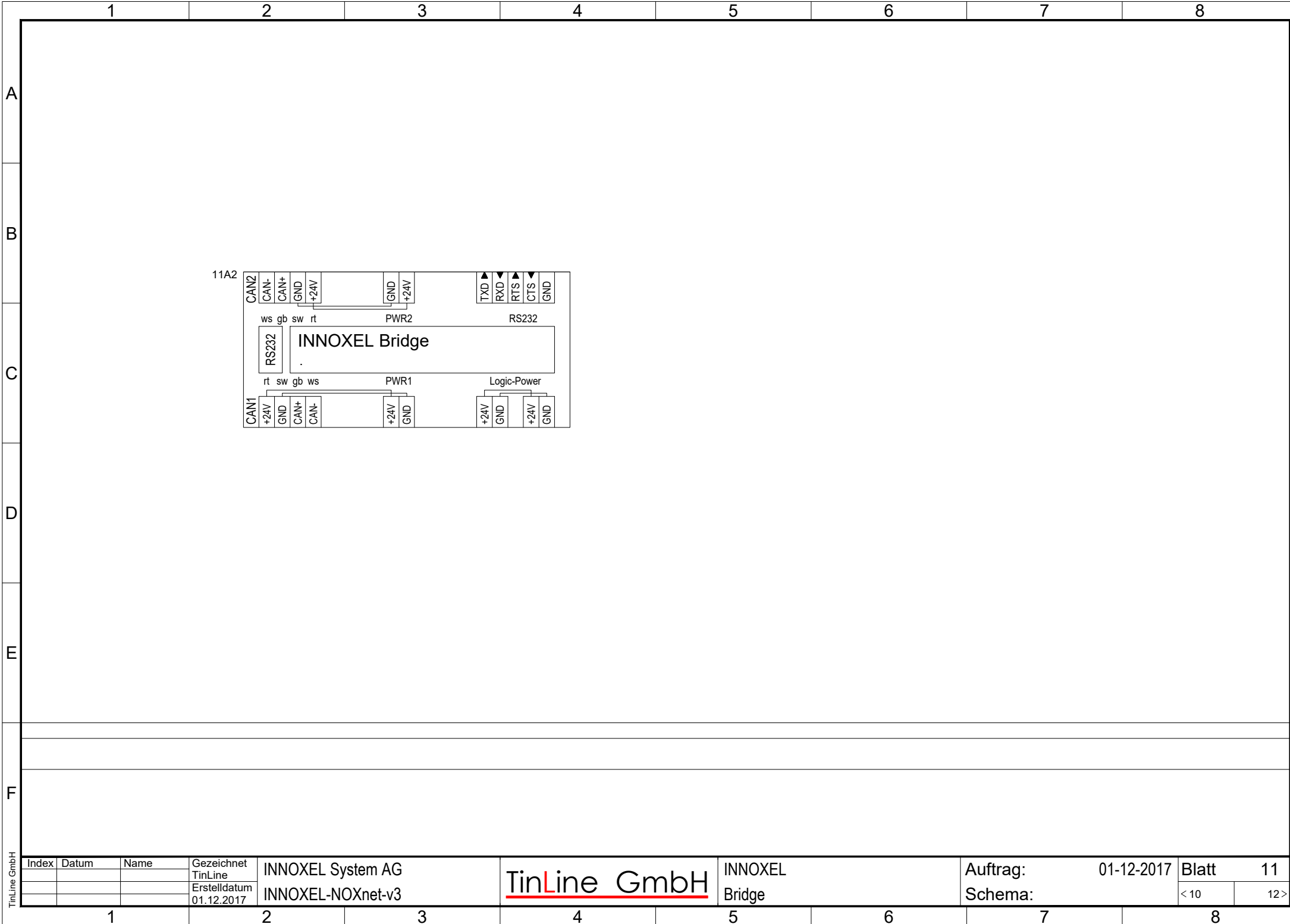

TinLine GmbH

Index	Datum	Name	Gezeichnet TinLine	INNOXEL System AG	TinLine GmbH	INNOXEL	Auftrag:	01-12-2017	Blatt	11
			Erstelldatum 01.12.2017	INNOXEL-NOXnet-v3		Bridge	Schema:		< 10	12 >

1

2

3

4

5

6

7

8

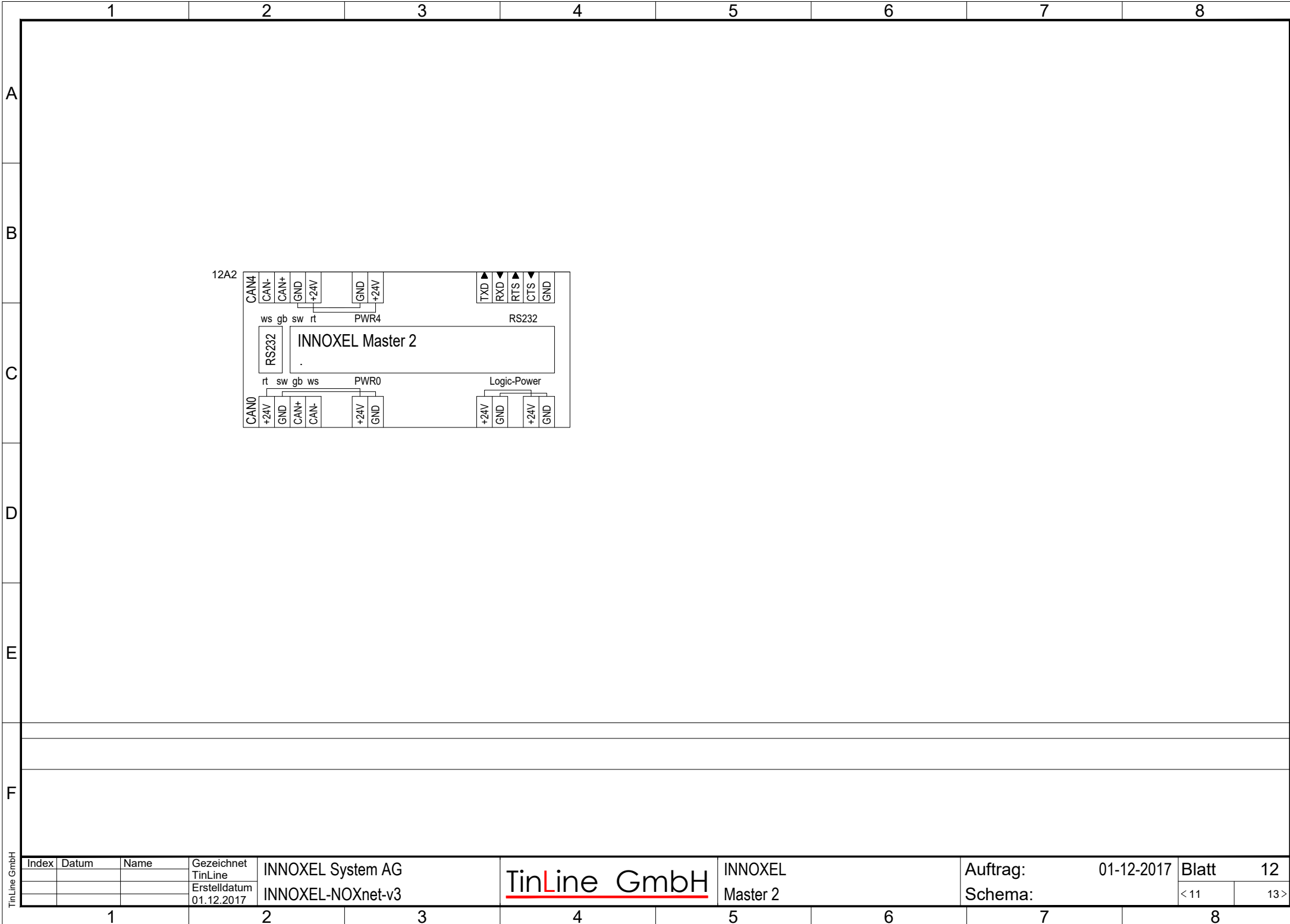

TinLine GmbH

Index	Datum	Name	Gezeichnet TinLine	INNOXEL System AG	TinLine GmbH	INNOXEL	Auftrag:	01-12-2017	Blatt	12
			Erstelldatum	INNOXEL-NOXnet-v3		Master 2	Schema:		< 11	13 >
			01.12.2017							

1

2

3

4

5

6

7

8

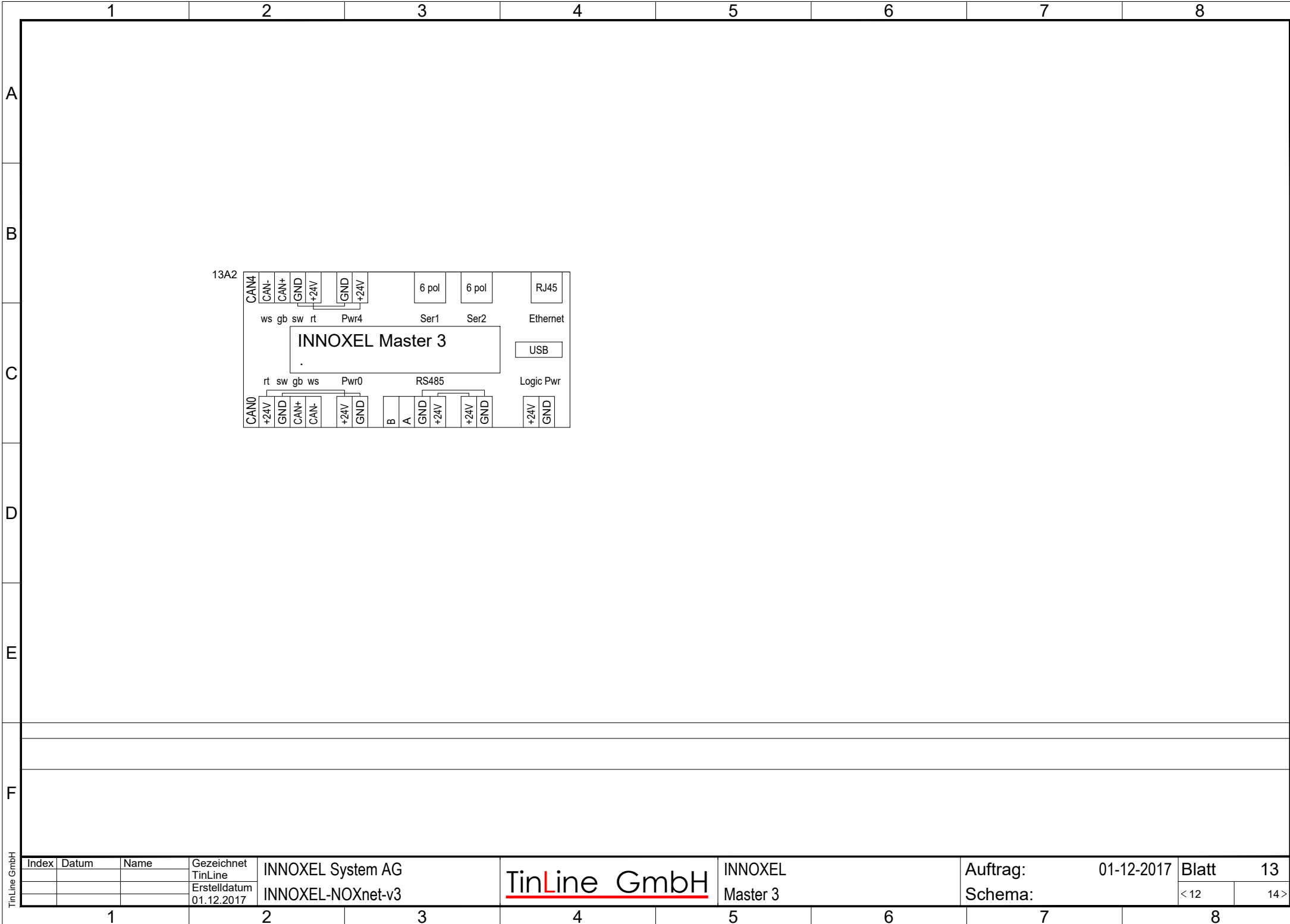

13A2

TinLine GmbH

Index	Datum	Name	Gezeichnet TinLine	INNOXEL System AG	TinLine GmbH	INNOXEL	Auftrag:	01-12-2017	Blatt	13
			Erstelldatum 01.12.2017	INNOXEL-NOXnet-v3		Master 3	Schema:		< 12	14 >

1

2

3

4

5

6

7

8

A

A

B

B

C

C

D

D

E

E

F

F

14A2

INNOXEL Buskoppler		für Wetterstation P03/3	
BUS		Zur Wetterstation U72 1x4x0.5 mit/ohne Schirm	
rot	schwarz	weiss	weiss
GND	gelb	blau	blau
CAN+	weiss	türkis	türkis
CAN-		violett	violett
+24V		1	1
		2	2
		A	A
		B	B

TinLine GmbH

Index	Datum	Name	Gezeichnet TinLine	INNOXEL System AG	TinLine GmbH	INNOXEL	Auftrag:	01-12-2017	Blatt	14
			Erstelldatum 01.12.2017	INNOXEL-NOXnet-v3		Buskoppler für Wetterstation	Schema:		< 13	15 >

1

2

3

4

5

6

7

8

1

2

3

4

5

6

7

8

A

A

B

B

15A2

INNOXEL		weiss	1
RS485		blau	2
Splitter		türkis	A
		violett	B
weiss	blau	türkis	violett
1	2	A	B

C

C

D

D

E

E

F

F

TinLine GmbH

Index	Datum	Name	Gezeichnet TinLine	INNOXEL System AG	TinLine GmbH	INNOXEL	Auftrag:	01-12-2017	Blatt	15
			Erstelldatum 01.12.2017	INNOXEL-NOXnet-v3		RS485 Splitter	Schema:		< 14	16 >

1

2

3

4

5

6

7

8

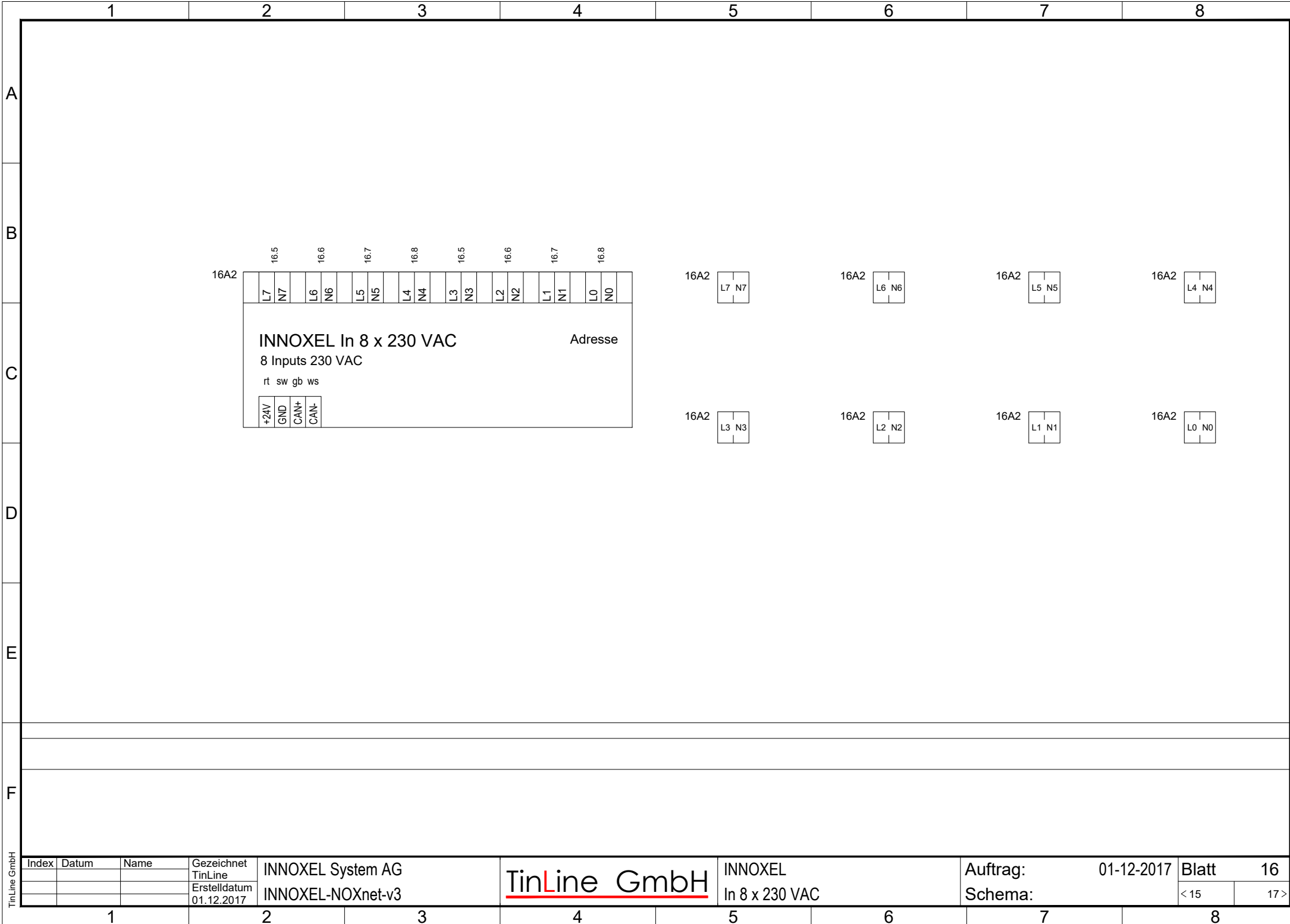

TinLine GmbH

Index	Datum	Name	Gezeichnet TinLine	INNOXEL System AG	<u>TinLine GmbH</u>	INNOXEL	Auftrag:	01-12-2017	Blatt	16
			Erstelldatum 01.12.2017	INNOXEL-NOXnet-v3		In 8 x 230 VAC	Schema:		< 15	17 >

1

2

3

4

5

6

7

8

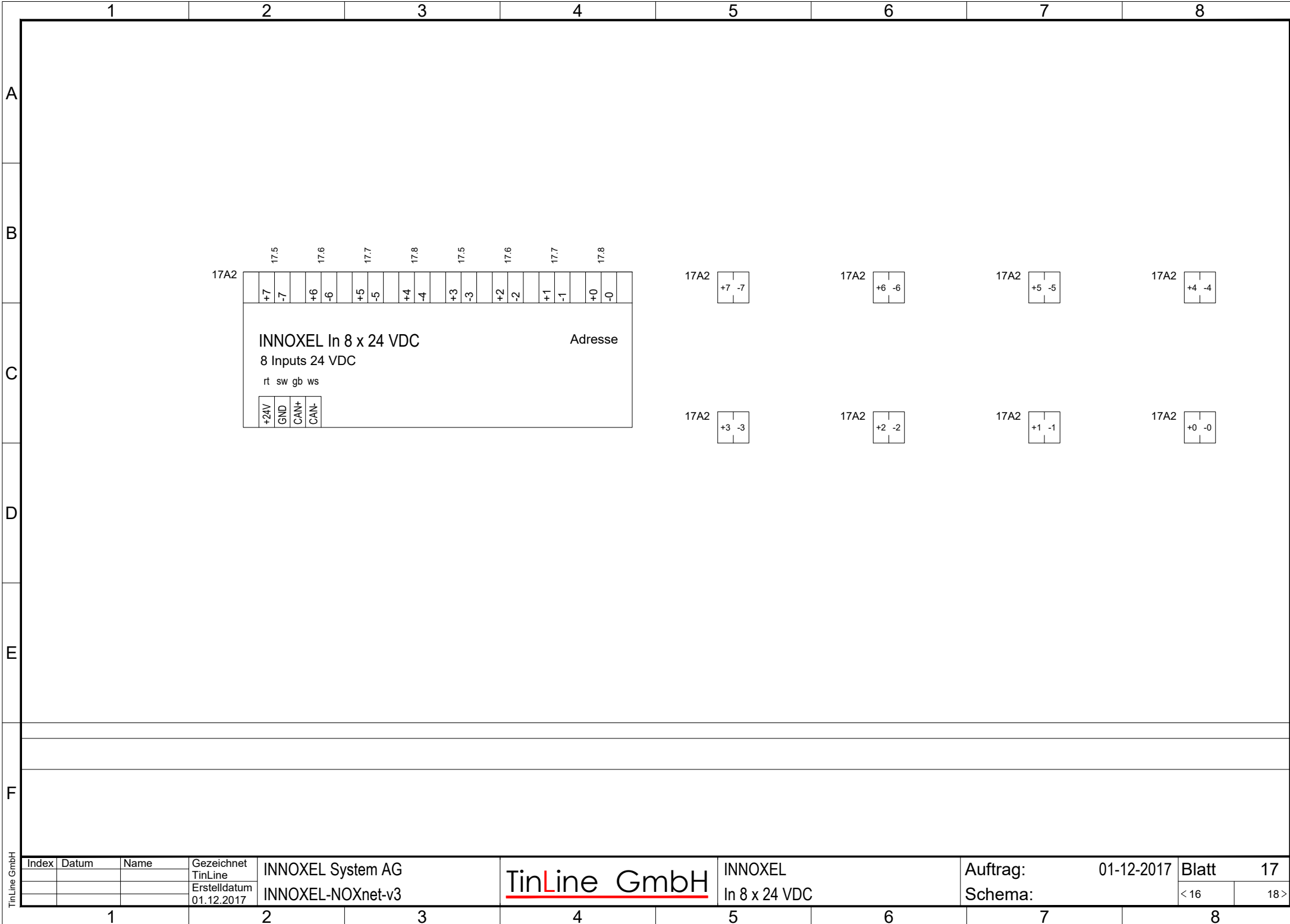

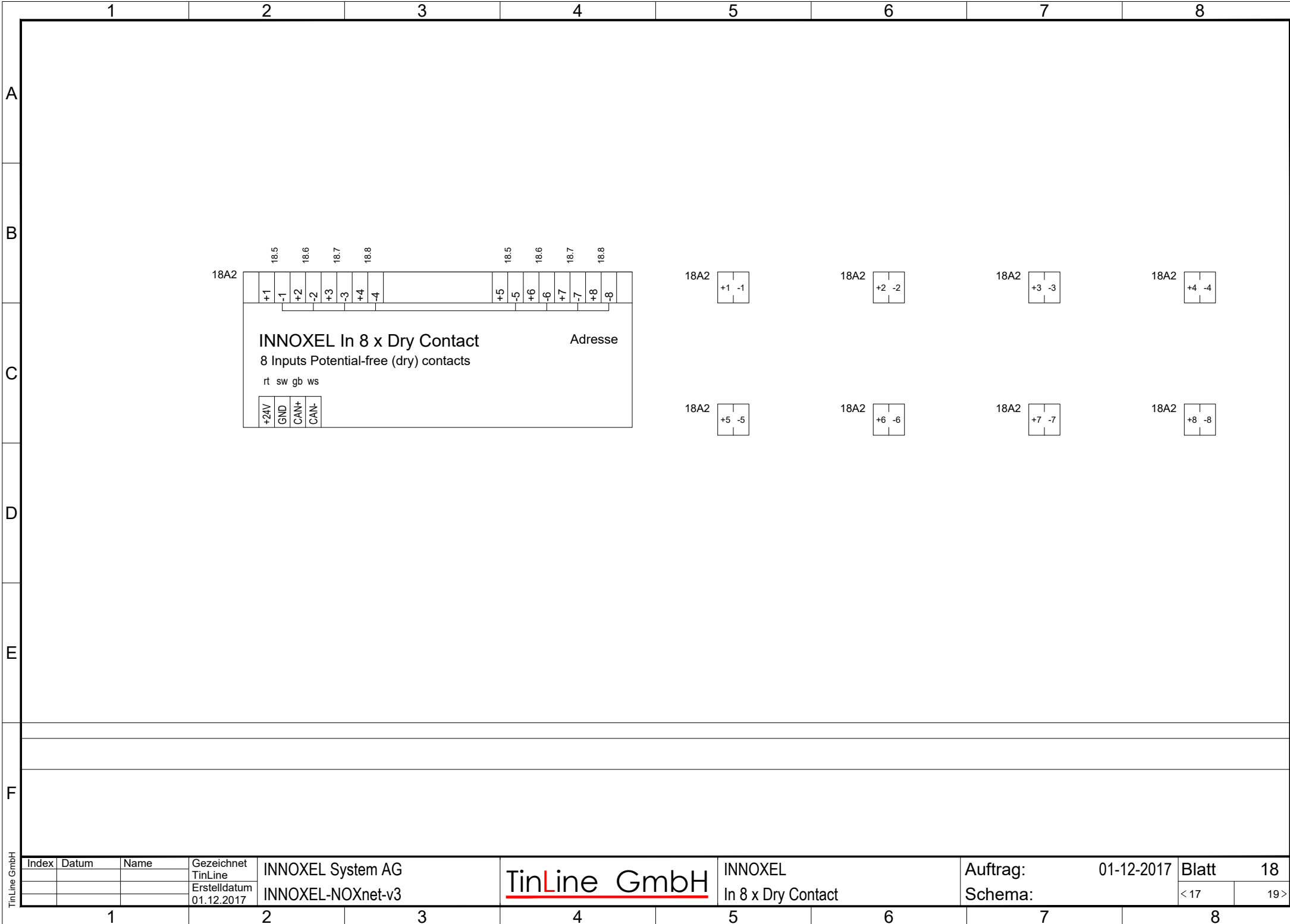

TinLine GmbH

Index	Datum	Name	Gezeichnet TinLine	INNOXEL System AG	TinLine GmbH	INNOXEL	Auftrag:	01-12-2017	Blatt	18
			Erstelldatum 01.12.2017	INNOXEL-NOXnet-v3		In 8 x Dry Contact	Schema:		< 17	19 >

1

2

3

4

5

6

7

8

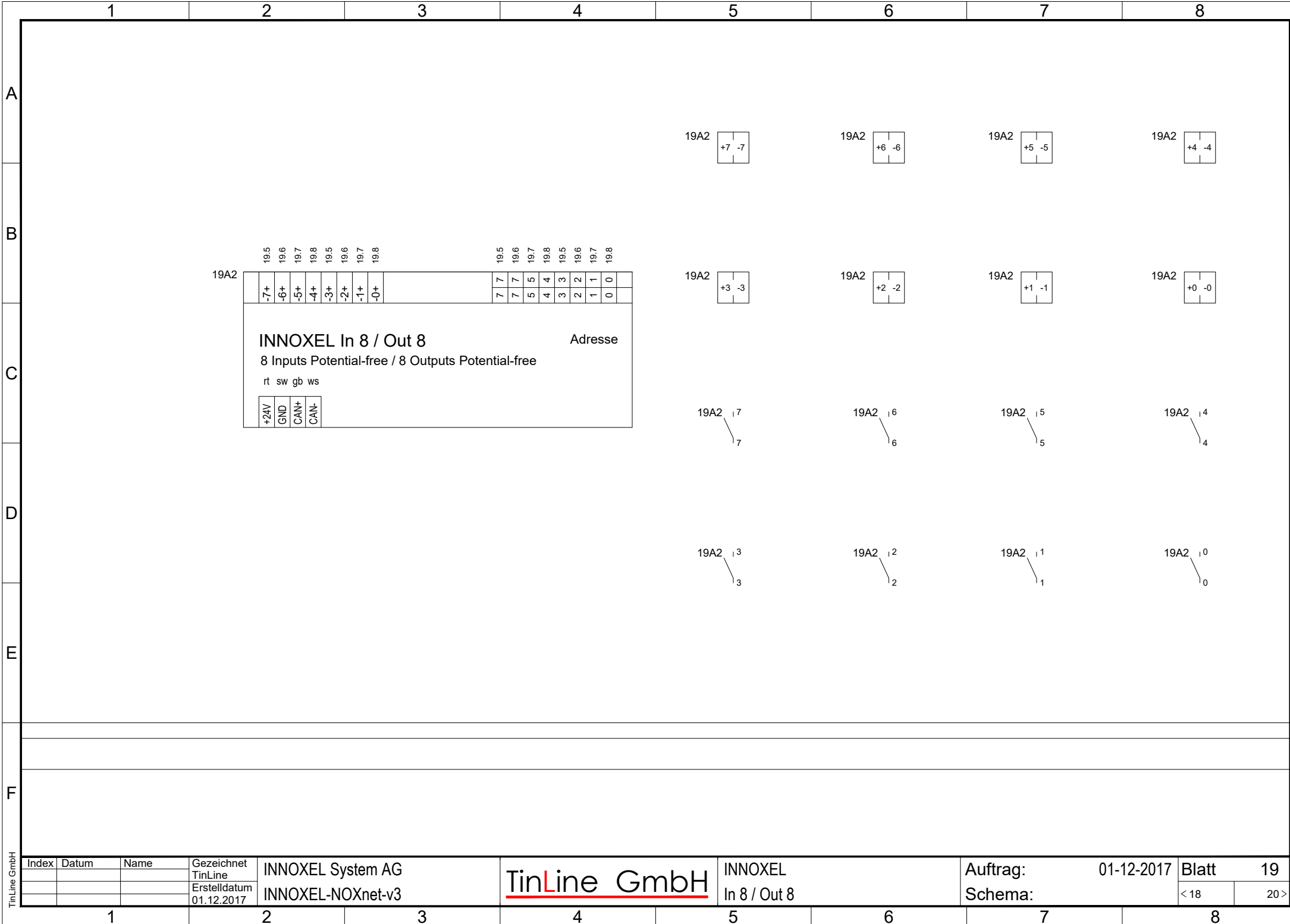

TinLine GmbH

Index	Datum	Name	Gezeichnet TinLine	INNOXEL System AG	TinLine GmbH	INNOXEL	Auftrag:	01-12-2017	Blatt	19
			Erstelldatum 01.12.2017	INNOXEL-NOXnet-v3		In 8 / Out 8	Schema:		< 18	20 >

1

2

3

4

5

6

7

8

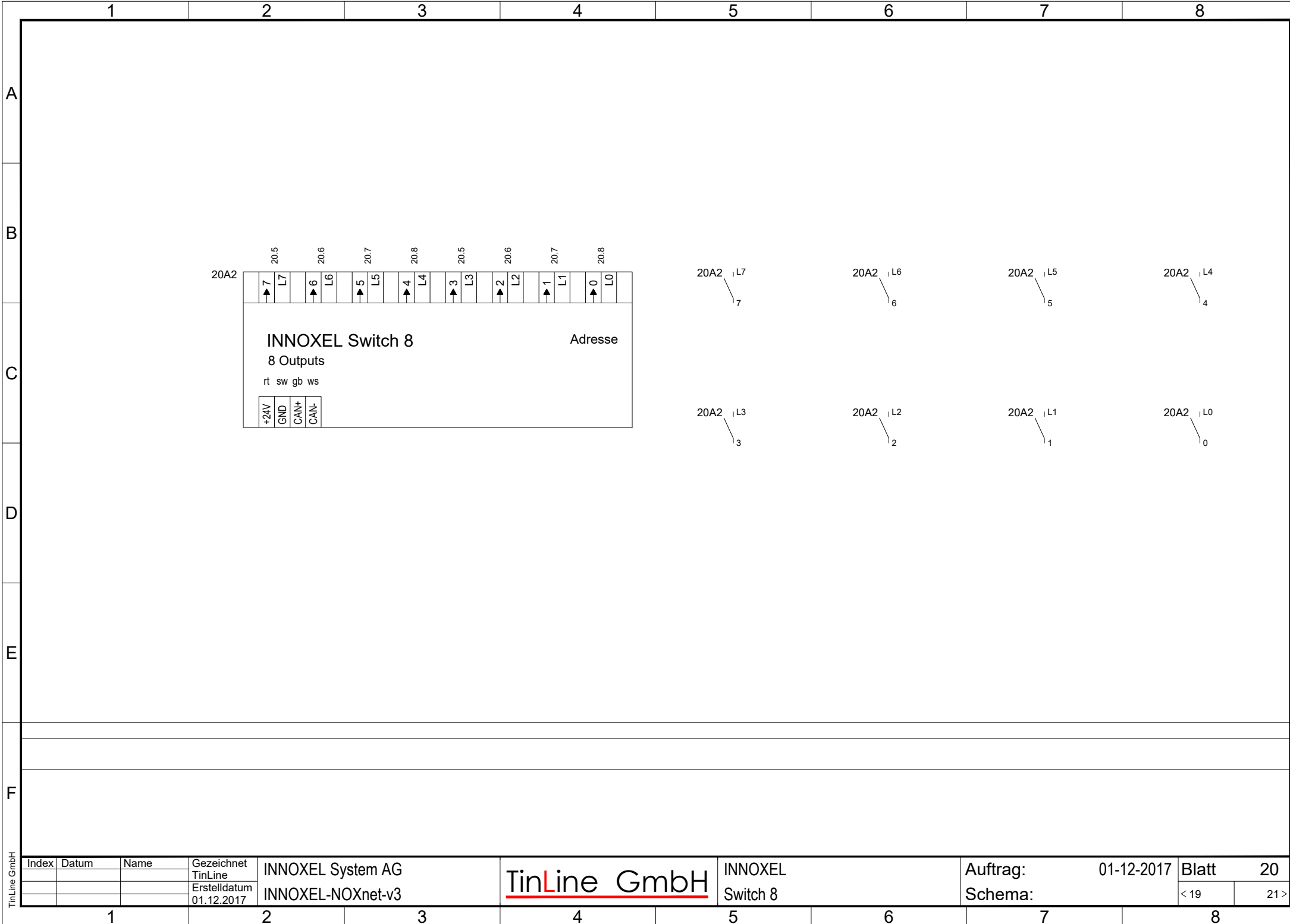

TinLine GmbH

Index	Datum	Name	Gezeichnet TinLine	INNOXEL System AG	TinLine GmbH	INNOXEL	Auftrag:	01-12-2017	Blatt	20
			Erstelldatum 01.12.2017	INNOXEL-NOXnet-v3		Switch 8	Schema:		< 19	21 >

1

2

3

4

5

6

7

8

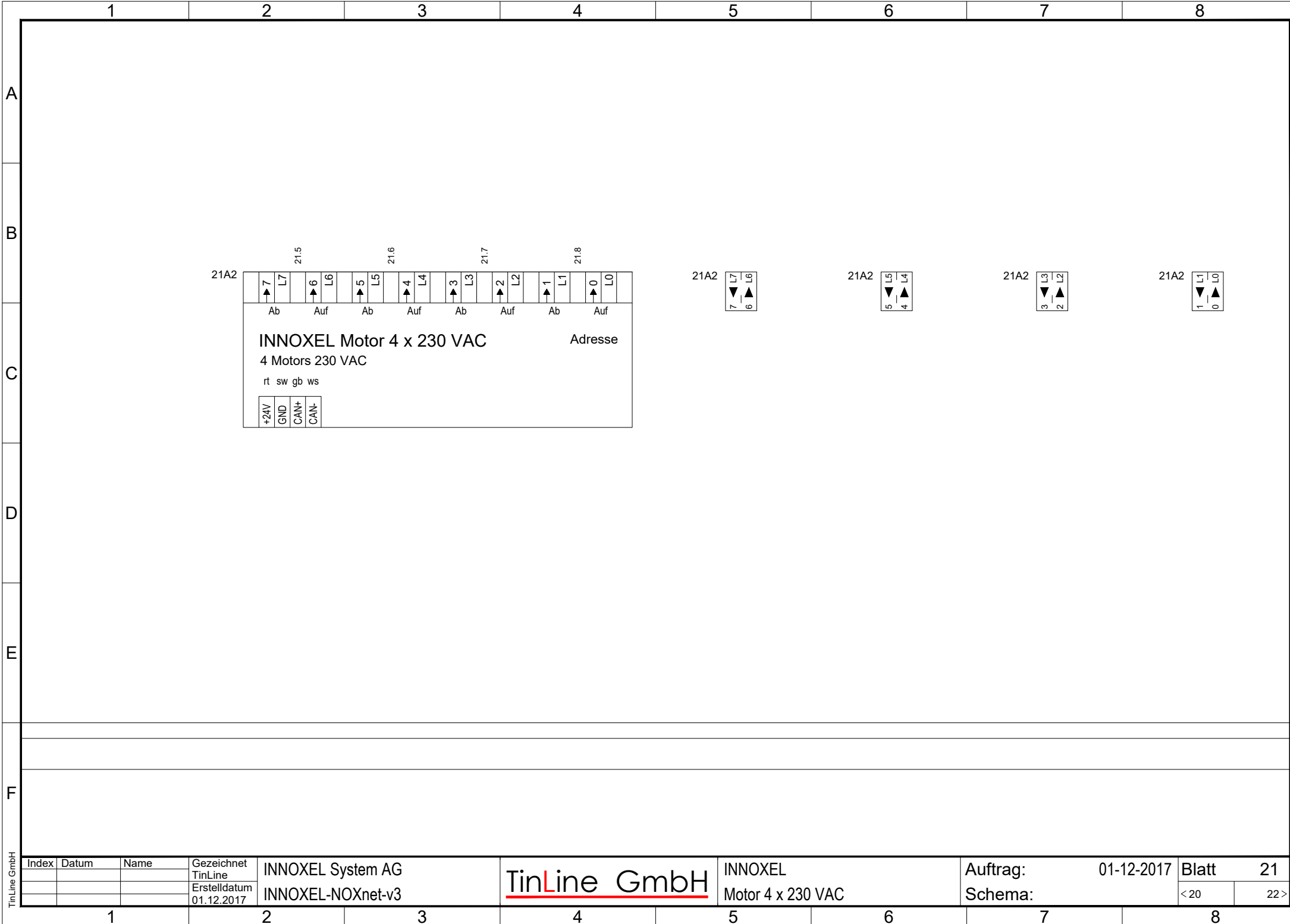

TinLine GmbH

Index	Datum	Name	Gezeichnet TinLine	INNOXEL System AG	<u>TinLine GmbH</u>	INNOXEL	Auftrag:	01-12-2017	Blatt	21
			Erstelldatum 01.12.2017	INNOXEL-NOXnet-v3		Motor 4 x 230 VAC	Schema:		< 20	22 >

1

2

3

4

5

6

7

8

1

2

3

4

5

6

7

8

A

A

B

B

C

C

D

D

E

E

F

F

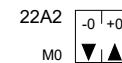
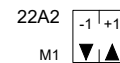
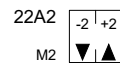
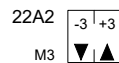
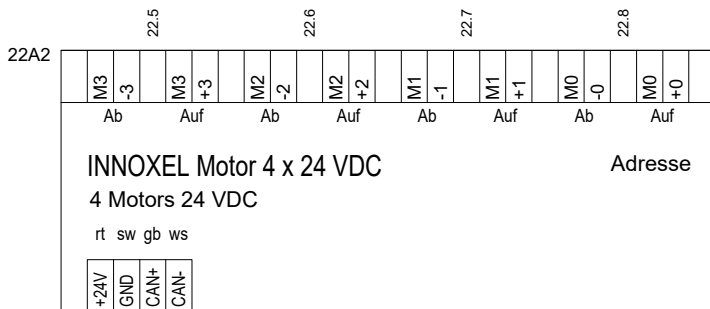

TinLine GmbH

Index	Datum	Name

Gezeichnet TinLine	INNOXEL System AG
Erstelldatum 01.12.2017	INNOXEL-NOXnet-v3

INNOXEL System AG
INNOXEL-NOXnet-v3

TinLine GmbH

INNOXEL
Motor 4 x 24 VDC

Auftrag: 01-12-2017
Schema:

Blatt 22
< 21 23 >

1

2

3

4

5

6

7

8

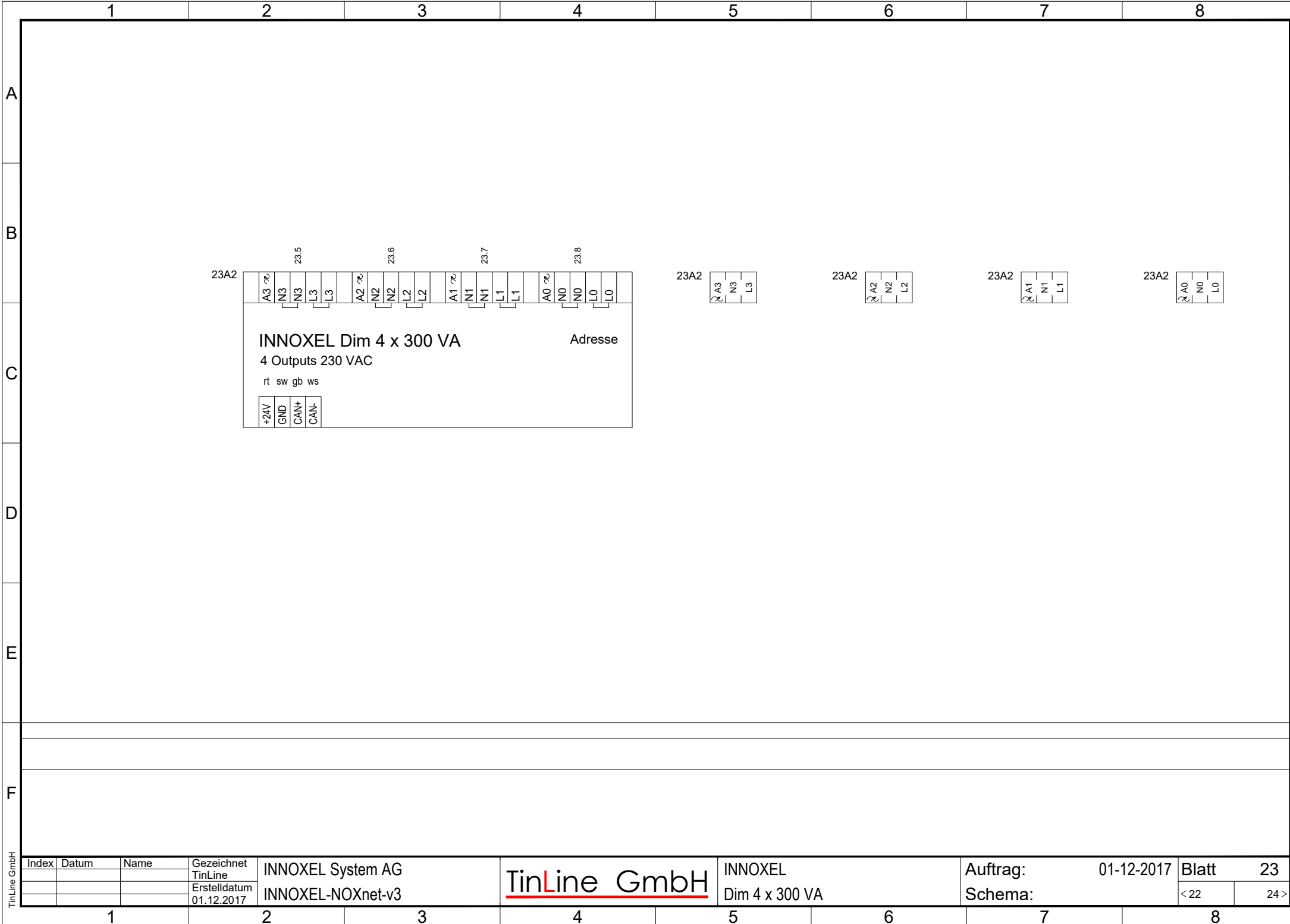

23A2

A3	N3	N3	L3	L3	A2	N2	N2	L2	L2	A1	N1	N1	L1	L1	A0	N0	N0	L0	L0
<p>INNOXEL Dim 4 x 300 VA Adresse</p> <p>4 Outputs 230 VAC</p> <p>rt sw gb ws</p>																			
+24V	GND	CAN+	CAN-																

23A2

A3	N3	L3
----	----	----

23A2

A2	N2	L2
----	----	----

23A2

A1	N1	L1
----	----	----

23A2

A0	N0	L0
----	----	----

TinLine GmbH

Index	Datum	Name	Gezeichnet TinLine	INNOXEL System AG	TinLine GmbH	INNOXEL	Auftrag:	01-12-2017	Blatt	23
			Erstelldatum 01.12.2017	INNOXEL-NOXnet-v3		Dim 4 x 300 VA	Schema:		< 22	24 >

1

2

3

4

5

6

7

8

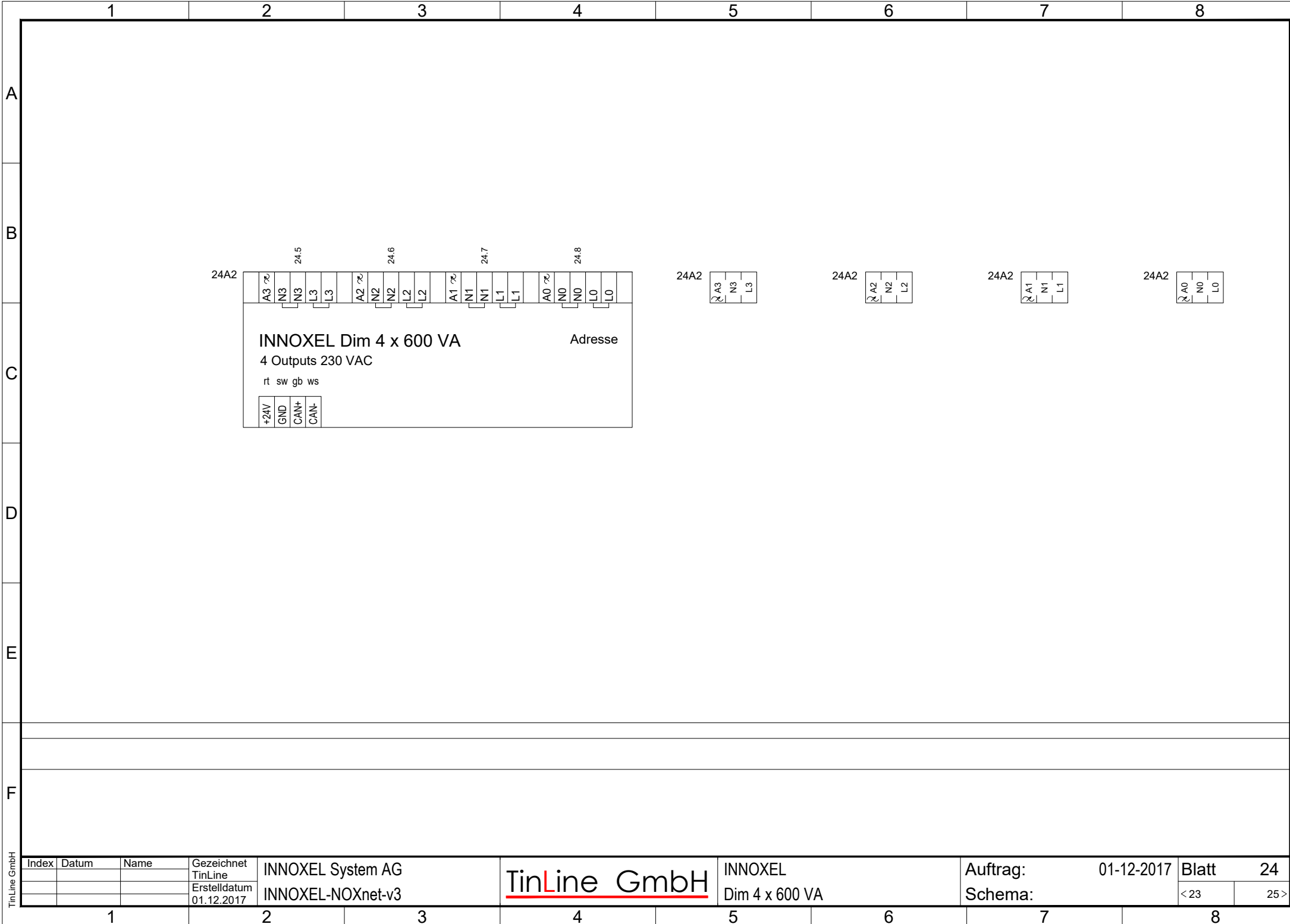

INNOXEL Dim 4 x 600 VA

Adresse

4 Outputs 230 VAC

rt sw gb ws

+24V	GND	CAN+	CAN-
------	-----	------	------

TinLine GmbH

Index	Datum	Name

Gezeichnet TinLine	INNOXEL System AG
Erstelldatum 01.12.2017	INNOXEL-NOXnet-v3

TinLine GmbH

INNOXEL
Dim 4 x 600 VA

Auftrag: 01-12-2017
Schema:

Blatt 24
< 23 25 >

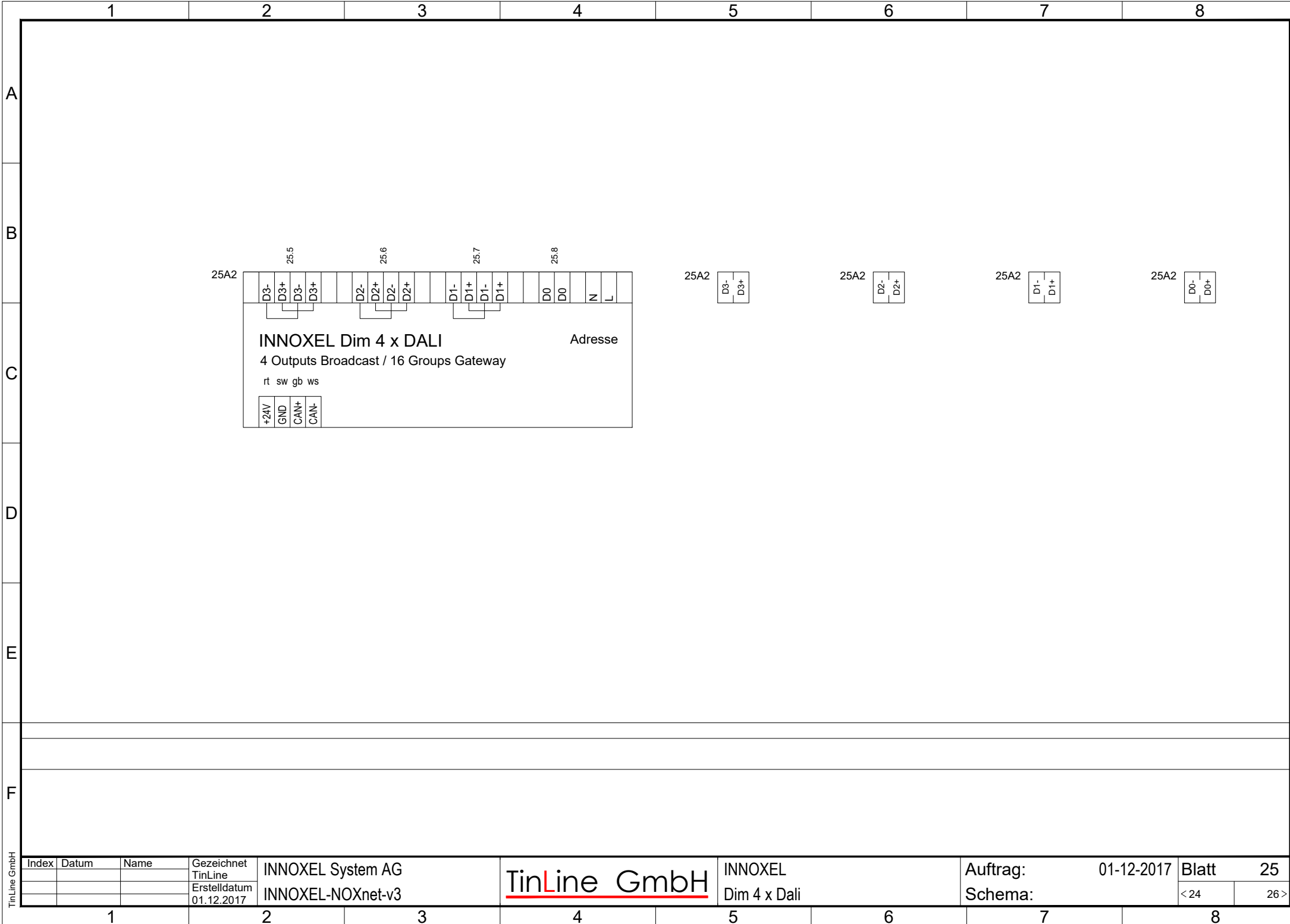

TinLine GmbH

Index	Datum	Name	Gezeichnet TinLine	INNOXEL System AG	TinLine GmbH	INNOXEL	Auftrag:	01-12-2017	Blatt	25
			Erstelldatum 01.12.2017	INNOXEL-NOXnet-v3		Dim 4 x Dali	Schema:		< 24	26 >

1

2

3

4

5

6

7

8

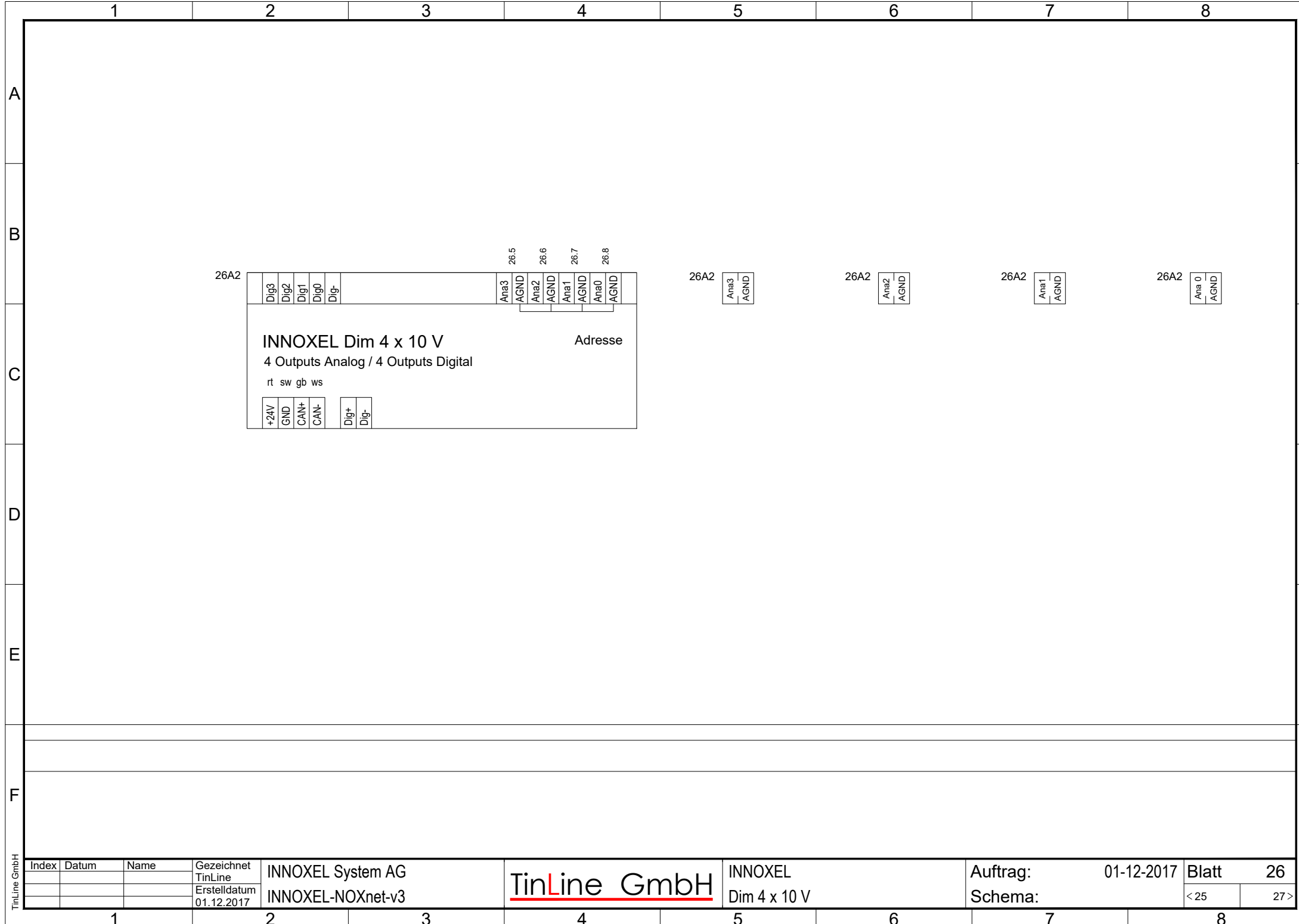

26A2

Dig3	Dig2	Dig1	Dig0	Dig-		Ana3	AGND	Ana2	AGND	Ana1	AGND	Ana0	AGND	
<p>INNOXEL Dim 4 x 10 V</p> <p>4 Outputs Analog / 4 Outputs Digital</p> <p>rt sw gb ws</p> <p>Adresse</p>														
+24V	GND	CAN+	CAN-	Dig+	Dig-									

26A2

Ana3	AGND
------	------

26A2

Ana2	AGND
------	------

26A2

Ana1	AGND
------	------

26A2

Ana0	AGND
------	------

TinLine GmbH

Index	Datum	Name	Gezeichnet TinLine	INNOXEL System AG		INNOXEL	Auftrag:	01-12-2017	Blatt	26
			Erstelldatum 01.12.2017	INNOXEL-NOXnet-v3		Dim 4 x 10 V	Schema:		< 25	27 >

1

2

3

4

5

6

7

8

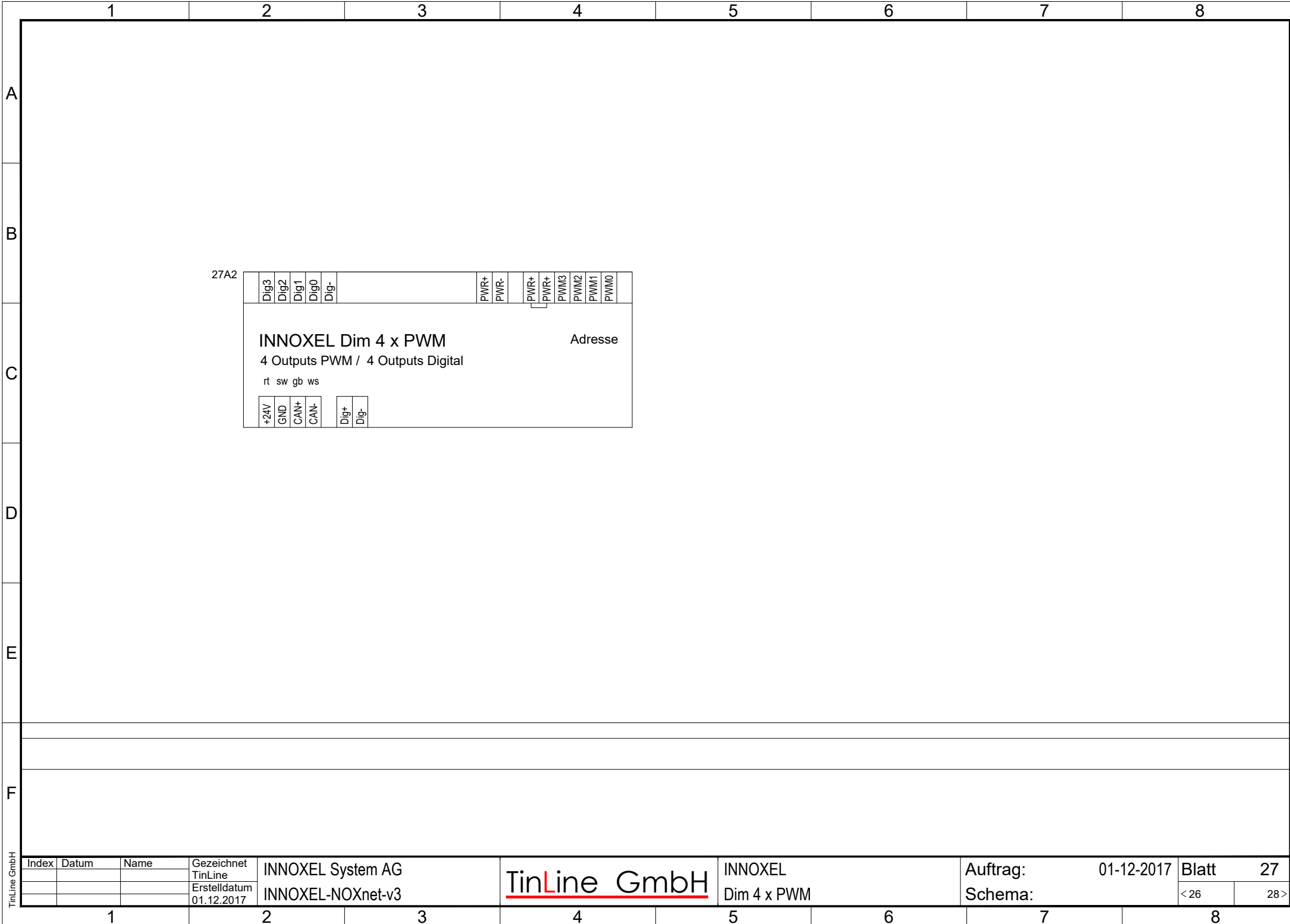

1

2

3

4

5

6

7

8

A

A

B

B

C

C

D

D

E

E

F

F

28A2

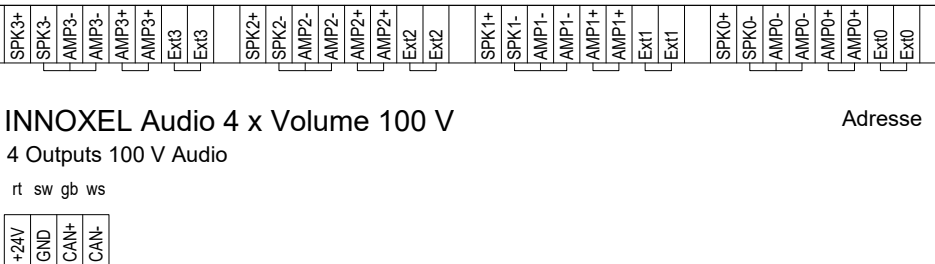

TinLine GmbH

Index	Datum	Name	Gezeichnet TinLine	INNOXEL System AG	TinLine GmbH	INNOXEL	Auftrag:	01-12-2017	Blatt	28
			Erstelldatum 01.12.2017	INNOXEL-NOXnet-v3		Audio 4 x Volume 100 V	Schema:		< 27	29 >

1

2

3

4

5

6

7

8

1

2

3

4

5

6

7

8

A

A

B

B

C

C

D

D

E

E

F

F

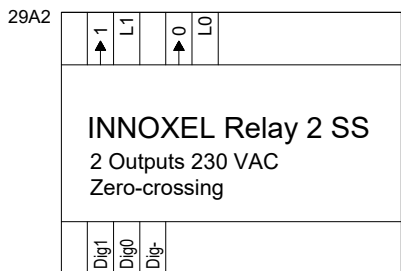

TinLine GmbH

Index	Datum	Name	Gezeichnet TinLine	INNOXEL System AG	<u>TinLine GmbH</u>	INNOXEL	Auftrag:	01-12-2017	Blatt	29
			Erstelldatum 01.12.2017	INNOXEL-NOXnet-v3		Relay 2 SS	Schema:		< 28	30 >

1

2

3

4

5

6

7

8

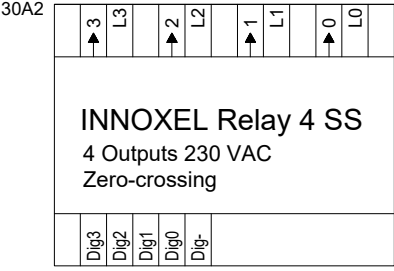
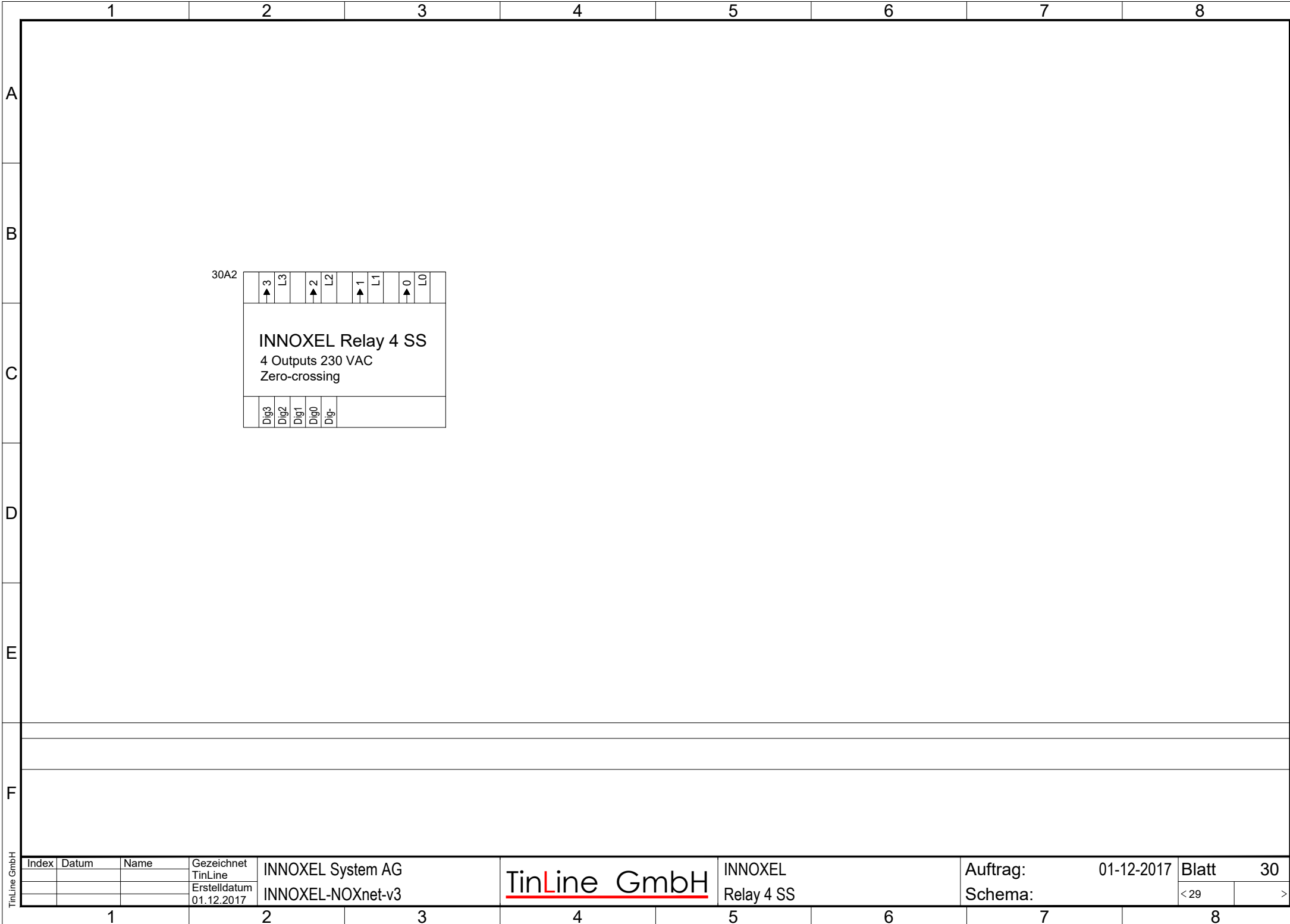

TinLine GmbH

Index	Datum	Name	Gezeichnet TinLine	INNOXEL System AG	TinLine GmbH	INNOXEL	Auftrag:	01-12-2017	Blatt	30
			Erstelldatum 01.12.2017	INNOXEL-NOXnet-v3		Relay 4 SS	Schema:		< 29	>

1

2

3

4

5

6

7

8